

# Product datasheet

Specifications



## SE Easy UPS, 500VA, Floor/Wall Mount, 230V, 4x CEE 7/3 Schuko outlets, AVR

BVS500I-GR

### Overview

Lead time Usually in Stock

### Main

Product or component type	Uninterruptible power supply (UPS)
Battery type	Lead-acid battery
Topology	Line interactive
Quantity per set	Set of 1
Reset	Automatic reset
Range of product	Easy UPS 1Ph BVS Series

### Complementary

Type of installation	Indoor
Surge Energy	156 J
Type of signal	Stepped approximation to a sinewave
Protection device type	Surge protection device (SPD) Miniature circuit breaker (MCB) Fuse
Input voltage	230 V AC
Output voltage	230 V
IP degree of protection	IP20
Transfer time	6 ms typical : 10 ms maximum
Network frequency	45...65 Hz
Power range	500 VA 300 W
Electrical connection	Input: 1 inlet Schuko CEE 7/P Output: 4 outlet Schuko CEE 7
Local signalling	Alarm, distinctive for low battery Alarm, continuous or intermittent tone for overload LED for battery status
Number of batteries	1
Charging time	8 h
Battery voltage	12 V
Battery capacity	4.5 Ah
Battery life	5 year(s)

Price is "List Price" and may be subject to a trade discount – check with your local distributor or retailer for actual price.

<b>Net weight</b>	3.9 kg
<b>Height</b>	92.5 mm
<b>Width</b>	160.5 mm
<b>Depth</b>	305 mm

## Environment

<b>Relative humidity</b>	0...90 %, non-condensing
<b>Operating altitude</b>	0...6561 ft
<b>Ambient air temperature for operation</b>	0...40 °C
<b>Standards</b>	EN/IEC 62040-1:2019/A11:2021 EN/IEC 62040-2:2006/AC:2006 EN/IEC 62040-2:2018
<b>Product certifications</b>	CE

## Physical

<b>Mounting support</b>	Wall Floor
-------------------------	---------------

## Packing Units

<b>Unit Type of Package 1</b>	PCE
<b>Number of Units in Package 1</b>	1
<b>Package 1 Height</b>	14.500 cm
<b>Package 1 Width</b>	23.500 cm
<b>Package 1 Length</b>	37.000 cm
<b>Package 1 Weight</b>	4.070 kg
<b>Unit Type of Package 2</b>	CAR
<b>Number of Units in Package 2</b>	4
<b>Package 2 Height</b>	25.000 cm
<b>Package 2 Width</b>	39.000 cm
<b>Package 2 Length</b>	58.000 cm
<b>Package 2 Weight</b>	20.050 kg
<b>Unit Type of Package 3</b>	P12
<b>Number of Units in Package 3</b>	48
<b>Package 3 Height</b>	105.000 cm
<b>Package 3 Width</b>	80.000 cm
<b>Package 3 Length</b>	120.000 cm
<b>Package 3 Weight</b>	252.600 kg
<b>SCC14</b>	10731304338441

## Contractual warranty

<b>Warranty</b>	2 years
-----------------	---------

## Sustainability

**Green Premium™ label** is Schneider Electric's commitment to delivering products with best-in-class environmental performance. Green Premium promises compliance with the latest regulations, transparency on environmental impacts, as well as circular and low-CO<sub>2</sub> products.

**Guide to assessing product sustainability** is a white paper that clarifies global eco-label standards and how to interpret environmental declarations.

[Learn more about Green Premium >](#)

[Guide to assess a product's sustainability >](#)



Transparency RoHS/REACH

## Well-being performance

Mercury Free

Rohs Exemption Information Yes

## Certifications & Standards

Reach Regulation [REACH Declaration](#)

Eu Rohs Directive Compliant with Exemptions

China Rohs Regulation [China RoHS declaration](#)  
Product out of China RoHS scope. Substance declaration for your information

Environmental Disclosure [Product Environmental Profile](#)

Weee The product must be disposed on European Union markets following specific waste collection and never end up in rubbish bins

Circularity Profile [End of Life Information](#)

Image of product / Alternate images

Alternative

---

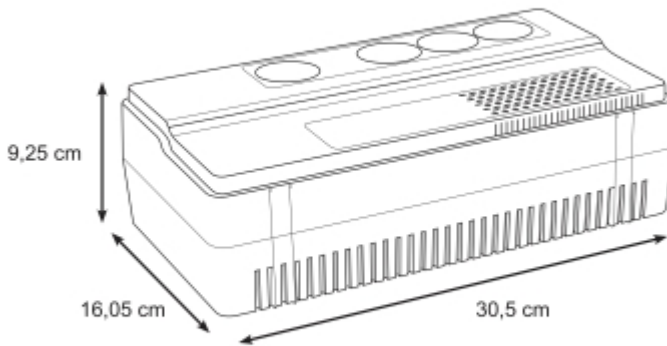



Image of product in real life situation

